



HEARTH PRODUCTS



⚠ WARNINGS



- Hot! Do not touch! The glass and surfaces of this appliance will be hot during operation and will retain heat for a while after shutting off the appliance. Severe burns may result.
- Carefully supervise children in the same room as appliance.
- If small children are present in the home, it is recommended that this appliance be fitted with a screen door or screen panel kit. See *Page 8* for ordering information.

WARNING: IF THE INFORMATION IN THIS MANUAL IS NOT FOLLOWED EXACTLY, A FIRE OR EXPLOSION MAY RESULT CAUSING PROPERTY DAMAGE, PERSONAL INJURY OR LOSS OF LIFE.

FOR YOUR SAFETY: Do not store or use gasoline or other flammable vapors or liquids in the vicinity of this or any other appliance.

FOR YOUR SAFETY: What to do if you smell gas:

- DO NOT light any appliance.
- DO NOT touch any electrical switches.
- DO NOT use any phone in your building.
- Immediately call your gas supplier from a neighbor's phone.

Follow your gas suppliers instructions.

- If your gas supplier cannot be reached, call the fire department.

Installation and service must be performed by a qualified installer, service agency or the gas supplier.



OMNI-Test Laboratories, Inc.

OTL Report No. 116-F-05-5

A French manual is available upon request. Order Form Number 875,021CF.

Ce manuel d'installation est disponible en français, simplement en faire la demande. Numéro de la pièce 875,021CF.

HOMEOWNER'S CARE AND OPERATION INSTRUCTIONS

DIRECT VENT ELITE® SERIES

VENTED GAS FIREPLACE HEATERS - DIRECT VENT MODELS
P/N 875,021M REV. G 03/2007

MODELS

Millivolt Models

EDV3530CNM
EDV4035CNM
EDV4540CNM
EDV3530CPM
EDV4035CPM
EDV4540CPM
EDV3530CNM-B
EDV4035CNM-B
EDV4540CNM-B
EDV3530CPM-B
EDV4035CPM-B
EDV4540CPM-B

Electronic Models

EDV3530CNE
EDV4035CNE
EDV4540CNE
EDV3530CNE-B
EDV4035CNE-B
EDV4540CNE-B

RETAIN THESE INSTRUCTIONS FOR FUTURE REFERENCE

AVERTISSEMENT: ASSUREZ-VOUS DE BIEN SUIVRE LES INSTRUCTIONS DONNÉ DANS CETTE NOTICE POUR RÉDUIRE AU MINIMUM LE RISQUE D'INCENDIE OU POUR ÉVITER TOUT DOMMAGE MATÉRIEL, TOUTE BLESSURE OU LA MORT.

POUR VOTRE SÉCURITÉ: Ne pas entreposer ni utiliser d'essence ni d'autre vapeurs ou liquides inflammables dans le voisinage de cet appareil ou de tout autre appareil.

POUR VOTRE SÉCURITÉ: Que faire si vous sentez une odeur de gaz:

- Ne pas tenter d'allumer d'appareil.
- Ne touchez à aucun interrupteur. Ne pas vous servir des téléphones se trouvant dans le bâtiment où vous vous trouvez.
- Evacuez la pièce, le bâtiment ou la zone.
- Appelez immédiatement votre fournisseur de gaz depuis un voisin. Suivez les instructions du fournisseur.
- Si vous ne pouvez rejoindre le fournisseur de gaz, appelez le service des incendies.

L'installation et service doit être exécuté par un qualifié installateur, agence de service ou le fournisseur de gaz.

CONGRATULATIONS!

In selecting this LENNOX Direct-Vent Gas Appliance you have chosen the finest and most dependable fireplace to be found anywhere. A beautiful, prestigious, alternative to a wood burning fireplace. Welcome to a Family of tens of thousands of satisfied LENNOX Fireplace Owners.

Please read and carefully follow all of the instructions found in this manual. Please pay special attention to the safety instructions provided in this manual. The Homeowner's Care and Operation Instructions included here will assure that you have many years of dependable and enjoyable service from your LENNOX product.

TABLE OF CONTENTS

Introduction	page	2
General Information	page	2
Operation/Care of Your Appliance	page	3
Variable Flame Adjustment	page	4
Glass Cleaning	page	5
Maintenance	page	5
Front Glass Enclosure Panel, Removal and Installation	page	5
Maintenance Schedule	page	6
Burner Adjustments	page	7
Flame Appearance and Sooting	page	7
Adjustment	page	7
Log Placement	page	8
Decorative Volcanic Stone Placement	page	9
Millivolt Appliance Checkout	page	9
Electronic Appliance Checkout	page	9
Accessory Components	page	9
Wiring Diagrams	page	14
Warranty	page	14
Replacement Parts	page	14
Product Reference Information	page	14
Lighting Instructions – Millivolt	page	16
Lighting Instructions – Electronic	page	18
Troubleshooting Guide – Millivolt	page	20
Troubleshooting Guide – Electronic	page	21
Replacement Parts List	page	22

INTRODUCTION

The Fireplace models covered in this manual are Direct-Vent sealed combustion gas fireplace heaters designed for residential application.

Direct-Vent appliances operate with the combustion chamber completely isolated from the inside atmosphere. All air for combustion is brought in from the outside and exhaust gases are vented through the same direct vent, vent system.

The millivolt appliances are designed to operate on either natural or propane gas. A millivolt gas control valve with piezo ignition system provides safe, efficient operation. External electrical power is required to operate the optional electrically powered components if installed. Electrical power must be wired during appliance installation.

The electronic appliances are designed to operate on either natural or propane gas. An electronic intermittent pilot system provides safe, efficient operation. External electrical power is required to operate these units.

These appliances comply with National Safety Standards and are tested and listed by Omni-Test Laboratories (Report No. 116-F-05-5) to ANSI Z21.88-2002 (in Canada, CSA-2.33-2002), and CAN/CGA-2.17-M91 in both USA and Canada, as vented gas fireplace heaters.

The Installation must conform to local codes or, in the absence of local codes, with the *National Fuel Gas Code, ANSI Z223.1/NFPA 54*, or the *Natural Gas and Propane Installation Code, CSA B149.1*. The appliance, when installed, must be electrically grounded in accordance with local codes or, in the absence of local codes, with the *National Electrical Code, ANSI/NFPA 70*, or the *Canadian Electrical Code, CSA C22.1*.

DO NOT ATTEMPT TO ALTER OR MODIFY THE CONSTRUCTION OF THE APPLIANCE OR ITS COMPONENTS. ANY MODIFICATION OR ALTERATION MAY VOID THE WARRANTY, CERTIFICATION AND LISTINGS OF THIS UNIT.

WARNING: IMPROPER INSTALLATION, ADJUSTMENT, ALTERATION, SERVICE OR MAINTENANCE CAN CAUSE INJURY OR PROPERTY DAMAGE. REFER TO THIS MANUAL. FOR ASSISTANCE OR ADDITIONAL INFORMATION CONSULT A QUALIFIED INSTALLER, SERVICE AGENCY OR THE GAS SUPPLIER.

WARNING: ELECTRONIC MODELS OF THESE APPLIANCES ARE EQUIPPED WITH A THREE-PRONG (GROUNDING) PLUG UTILIZED IN CONNECTING THE ELECTRONIC COMPONENTS TO THE JUNCTION BOX IN THE LOWER COMPARTMENT. THIS GROUNDING PLUG PROVIDES PROTECTION AGAINST SHOCK HAZARD AND SHOULD BE PLUGGED DIRECTLY INTO THE PROPERLY GROUNDED THREE-PRONG RECEPTACLE. DO NOT CUT OR REMOVE THE GROUNDING PRONG FROM THE PLUG.

GENERAL INFORMATION

Note: Installation and repair should be performed by a qualified service person. The appliance should be inspected annually by a qualified professional service technician. More frequent inspections and cleanings may be required due to excessive lint from carpeting, bedding material, etc. It is imperative that the control compartment, burners and circulating air passage ways of the appliance be kept clean.

S'assurer que le brûleur et le compartiment des commandes sont propres. Voir les instructions d'installation et d'utilisation qui accompagnent l'appareil.

Provide adequate clearances around air openings and adequate accessibility clearance for service and proper operation. Never obstruct the front openings of the appliance.

Due to high temperatures the appliance should be located out of traffic and away from furniture and draperies. Locate furniture and window coverings accordingly.

WARNING: THESE FIREPLACES ARE VENTED HEATERS. DO NOT BURN WOOD OR OTHER MATERIAL IN THESE APPLIANCES.

These appliances are designed to operate on natural or propane gas only.

Millivolt Models -

Input of millivolt models is shown in the following table:

Millivolt Models with Manually-Modulated Gas Valve			
Natural Gas		Propane Gas	
Model No.	Input rate (BTU/H)	Model No.	Input rate (BTU/H)
EDV3530	21,000 to 27,000	EDV3530	20,700 to 27,000
	23,500 to 30,000		24,200 to 30,000
EDV4540	26,000 to 33,000	EDV4540	26,500 to 33,000

Electronic Models -

Electronic models have a fixed rate gas valve. Input of electronic models is shown in the following table:

Electronic Models with Fixed-Rate Gas Valve	
Natural and Propane Gas	
Model No.	Input rate (BTU/H)
EDV3530	27,000
EDV4035	30,000
EDV4540	33,000

Table 1 shows the units' gas orifice size for the elevations indicated.

Model No.	Orifice size		Elevation Feet (meters)
	Nat.	Prop.	
EDV3530	#40	#53	0-4500 (0-1372)
EDV4035	#36	#52	
EDV4540	#33	#51	

Table 1

Maximum manifold pressure is 3.5 in. w.c. (0.87 kPa) for natural gas and 10 in. w.c. (2.49 kPa) for LP/Propane gas.

Do not use these appliances if any part has been under water. Immediately call a qualified, professional service technician to inspect the appliance and to replace any parts of the control system and any gas control which have been under water.

Ne pas se servir de cet appareil s'il a été plongé dans l'eau, complètement ou en partie. Appeler un technicien qualifié pour inspecter l'appareil et remplacer toute partie du système de contrôle et toute commande qui ont été plongés dans l'eau.

Test gage connections are provided on the front of the millivolt gas control valve (identified OUT for the manifold side and IN for inlet pressure). A 1/8" NPT test gage connection is provided on the electronic gas control valve adjacent to the outlet to the main burner.

Minimum inlet gas pressure to these appliances is 5.0 inches water column (1.24 kPa) for natural gas and 11 inches water column (2.74 kPa) for propane for the purpose of input adjustment.

Maximum inlet gas supply pressure to these appliances is 10.5 inches water column (2.61 kPa) for natural gas and 13.0 inches water column (3.23 kPa) for propane.

The appliance must be isolated from the gas supply piping system (by closing its individual manual shut-off valve) during any pressure testing of the gas supply piping system at test pressures equal to or less than 1/2 psig (3.5 kPa).

The appliance and its individual shut-off valve must be disconnected from the gas supply piping system during any pressure testing of that system at pressures in excess of 1/2 psig (3.5 kPa).

These appliances must not be connected to a chimney or flue serving a separate solid fuel burning appliance.

Any safety guard or screen removed for servicing the appliance must be replaced prior to operating the appliance.

WARNING: FAILURE TO COMPLY WITH THE INSTALLATION AND OPERATING INSTRUCTIONS PROVIDED IN THIS DOCUMENT WILL RESULT IN AN IMPROPERLY INSTALLED AND OPERATING APPLIANCE, VOIDING ITS WARRANTY. ANY CHANGE TO THIS APPLIANCE AND/OR ITS OPERATING CONTROLS IS DANGEROUS. IMPROPER INSTALLATION OR USE OF THIS APPLIANCE CAN CAUSE SERIOUS INJURY OR DEATH FROM FIRE, BURNS, EXPLOSION OR CARBON MONOXIDE POISONING.

Carbon Monoxide Poisoning: Early signs of carbon monoxide poisoning are similar to the flu with headaches, dizziness and/or nausea. If you have these signs, obtain fresh air immediately. Turn off the gas supply to the appliance and have it serviced by a qualified professional, as it may not be operating correctly.

WARNING: CHILDREN AND ADULTS SHOULD BE ALERTED TO THE HAZARDS OF HIGH SURFACE TEMPERATURES. USE CAUTION AROUND THE APPLIANCE TO AVOID BURNS OR CLOTHING IGNITION. YOUNG CHILDREN SHOULD BE CAREFULLY SUPERVISED WHEN THEY ARE IN THE SAME ROOM AS THE APPLIANCE.

WARNING: DO NOT PLACE CLOTHING OR OTHER FLAMMABLE MATERIALS ON OR NEAR THIS APPLIANCE.

AVERTISSEMENT: SURVEILLER LES ENFANTS. GARDER LES VÊTEMENTS, LES MEUBLES, L'ESSENCE OU AUTRES LIQUIDES À VAPEUR INFLAMMABLES LOIN DE L'APPAREIL.

OPERATION AND CARE OF YOUR APPLIANCE

Appliance operation may be controlled by the following means: the factory provided modesty panel-mounted ON-OFF control switch, a remotely located optional wall switch or optional remote control. The modesty panel mounted ON-OFF control switch is located behind the hinged drop-down panel below the appliance front glass enclosure panel. See *Figure 1*.

Gas Controls/Control Compartment Access

The gas controls can be found behind the hinged drop-down panel.

To open the hinged drop-down panel, actuate the spring loaded magnetic catches securing the door. First, gently depress the upper right top corner of the panel until the magnet catch "pops" the door free. Then, gently pulling the panel forward, disengage the left magnet catch and allow the panel to swing down to open.

On millivolt systems, the piezo ignitor, Hi/Lo flame adjustment knob, and pilot and main gas ON/OFF control knob are located on the modesty panel. On both millivolt and electronic systems the gas valve is located behind the modesty panel. See *Figure 1*.

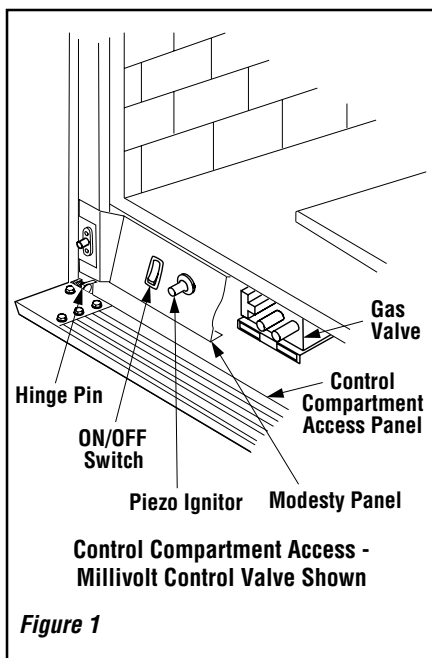

Remove the bottom compartment door by sliding the hinge pin, located at the door's left side, to the right until it disengages from the left corner post hole. Pull the door diagonally to the left, away from the fireplace.

Once the control compartment door has been removed, the modesty panel can be removed as follows: slide the modesty panel forward until it contacts the cabinet bottom panel, then lift straight up and tilt forward. Remove the modesty panel carefully, so that none of the wires become loose or disconnected. Now complete access to the gas control valve and its related controls is attainable.

To ease door closure, depress the catches to place them in their retracted position until they stay there, then close the door.

Operation of millivolt and electronic gas control systems are different. Before lighting and operating your appliance determine if you have a millivolt or electronic appliance.

Refer to **Figure 1** for access to the gas control valve. Millivolt appliances will be fitted with the gas control valve shown in **Figure 2**.

Appliances with electronic systems will be fitted with the electronic valve shown in **Figure 3**. Familiarize yourself with the gas control valve that your appliance uses.

Millivolt Appliances -

To light millivolt appliances refer to the detailed lighting instructions found on **page 11 (English) and page 12 (French)**. **Millivolt appliance lighting instructions may also be found on the pull out lighting instruction labels attached to the gas control valve.**

Millivolt appliances are fitted with an ON/OFF Rocker Switch for appliance ON/OFF control. See **Figure 1** for its location. Once the pilot is lit, the ON/OFF rocker switch will control the appliance ON/OFF operation. To operate: Toggle the switch between its ON and OFF positions.

If your millivolt appliance is equipped with an optional remote wall switch or remote control kit and the pilot is lit, the appliance main burner may be turned on and off with the wall switch or remote control.

Electronic Appliances -

To light electronic appliances refer to the detailed lighting instructions found in both English and French on **pages 13 and 14** of these instructions respectively. **Electronic appliance lighting instructions may also be found on the pull out lighting instruction labels attached to the gas control valve.** Electronic appliances are fitted with an ON/OFF Rocker Switch for appliance ON/OFF control. See **Figure 1** for its location.

Once the pilot is lit, the ON/OFF rocker switch will control the appliance ON/OFF operation. To operate: Toggle the switch between its ON and OFF positions.

If your electronic appliance is equipped with an optional remote wall switch or remote control kit the appliance main burner may be turned on and off with the wall switch or remote control.

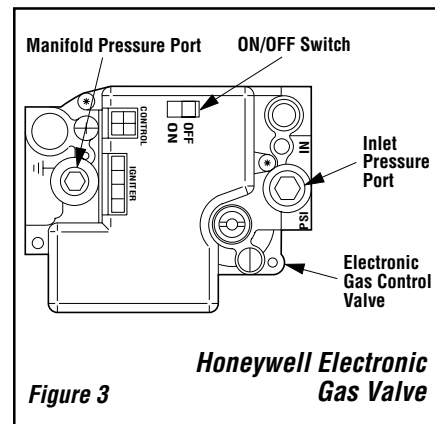

Variable Flame Height Adjustment (Millivolt Appliances only)

1. All Millivolt appliances are equipped with a variable gas control valve. Flame height for these models may be adjusted through a range between fixed low and high settings, alternately, while the appliance is in operation.

Adjust the flame height as desired after lighting the appliance by rotating the variable adjustment control knob located on the front of the valve (**refer to Figure 2**). (An extension is provided to this knob so that the adjustment may be made at the modesty panel.)

2. When lit for the first time, this appliance will emit a slight odor for an hour or two. This is due to the "burn-in" of internal paints and lubricants used in the manufacturing process.

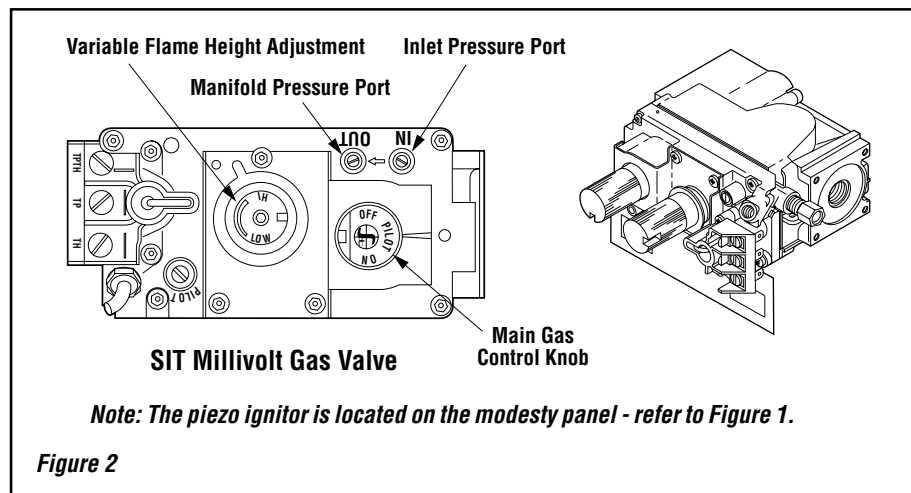

3. Keep lower control compartment clean by vacuuming or brushing at least twice a year. More frequent cleaning may be required due to excessive lint from carpeting, bedding materials, etc. It is important that control compartments, burners and circulating air passages of the appliance be kept clean and clear of obstruction of venting and combustion air.

4. Always turn off gas to the pilot (millivolt appliances) before cleaning. Before re-lighting, refer to the lighting instructions in this manual. Instructions are also found on a pull-out panel located on the floor of the appliance.

5. Always keep the appliance area clear and free from combustible materials, gasoline and other flammable liquids.

6. Remember, Millivolt appliances have a continuous burning pilot flame. Exercise caution when using products with combustible vapors.

Glass Cleaning

It will be necessary to clean the glass periodically. During start-up it is normal for condensation to form on the inside of the glass. This can cause lint, dust and other airborne particles to cling to the glass surface. Also initial paint curing may deposit a slight film on the glass. It is therefore recommended that the glass be cleaned two or three times with a non-ammonia household cleaner and warm water (a gas fireplace glass cleaner is recommended). After that the glass should be cleaned two or three times during each heating season, depending on the circumstances present.

Note: Clean glass after first two weeks of operation.

WARNING: DO NOT USE ABRASIVE CLEANERS. NEVER CLEAN THE GLASS WHEN IT IS HOT.

CAUTION: DO NOT ATTEMPT TO TOUCH THE FRONT ENCLOSURE GLASS WITH YOUR HANDS WHILE THE FIREPLACE IS IN USE.

Maintenance

The appliance and venting system should be thoroughly inspected before initial use and at least annually by a qualified service technician. However, more frequent periodic inspections and cleanings should be performed by the homeowner. **Homeowner must contact a qualified service technician at once if any abnormal condition is observed.**

Refer to the maintenance schedule for maintenance tasks, procedures, periodicity and by whom they should be performed. Always verify proper operation of the appliance after servicing.

IMPORTANT: TURN OFF GAS AND ANY ELECTRICAL POWER BEFORE SERVICING THE APPLIANCE.

Front Glass Enclosure Panel, Removal and Installation

WARNING: DO NOT OPERATE APPLIANCE WITH THE GLASS FRONT REMOVED, CRACKED OR BROKEN. REPLACEMENT OF THE GLASS SHOULD BE DONE BY A LICENSED OR QUALIFIED SERVICE TECHNICIAN.

These are direct-vent appliances. They are designed to operate only when the front glass enclosure panel is installed. Generally the front glass enclosure panel should not be removed except to gain access to the components within the firebox, and the appliance may only be operated without the front glass enclosure panel in place for very brief periods of time during appliance checkout and adjustment.

During this appliance checkout and adjustment period, a potential safety hazard exists - EXERCISE EXTREME CAUTION to prevent the occurrence of any burn injuries from the exposed flames or hot surfaces.

Also note, that while the front glass enclosure panel is removed, the flame appearance will appear to be smaller than normal.

WARNING: HANDLE THIS GLASS WITH EXTREME CARE! DO NOT STRIKE DOOR. TEMPERED GLASS IS SUSCEPTIBLE TO DAMAGE— DO NOT SCRATCH OR HANDLE ROUGHLY WHILE REINSTALLING THE GLASS DOOR FRAME.

WARNING: NO NOT ATTEMPT TO SUBSTITUTE THE MATERIALS USED ON THIS DOOR, OR REPLACE CRACKED OR BROKEN GLASS WITH ANY MATERIALS OTHER THAN THOSE PROVIDED BY THE APPLIANCE MANUFACTURER.

THE GLASS DOOR OF THIS APPLIANCE MUST ONLY BE REPLACED AS A COMPLETE UNIT AS PROVIDED BY THE MANUFACTURER. DO NOT ATTEMPT TO REPLACE BROKEN, CRACKED OR CHIPPED GLASS SEPARATELY.

Refer to *Figure 4* and remove the front glass enclosure panel as follows:

1. Remove the top bustle, and the top louver assembly or radiant panel.
2. Remove the bottom bustle, and open the hinged drop-down control compartment panel.
3. Remove the bottom compartment door by sliding the hinge pin, located at the door's left side, to the right until it disengages from the left corner post hole. Pull the door diagonally to the left, away from the fireplace.
4. Locate the two (2) latches at the top of the control compartment and disengage them from the floor frame bottom Vee-flange, pulling down on their handles to open them.
5. Swing the bottom of the door out and raise it slightly to lift the top flange of the door frame away from the appliance.

Maintenance Schedule

Annually (Before the onset of the Burning Season)

Maintenance Task	Accomplishing Person	Procedure
Inspecting/Cleaning Burner, Logs and Controls	Qualified Service Technician	Inspect valve and ensure it is properly operating. Check piping for leaks. Vacuum the control compartment, fireplace logs and burner area.
Check Flame Patterns and Flame Height	Qualified Service Technician	Refer to Figures 6 (EDV3530), 7 (EDV4035) or 8 (EDV4540) on page 7 and verify the flame pattern and height displayed by the appliance conforms to the picture. Flames must not impinge on the logs.
Inspecting/Cleaning Pilot and Burner	Qualified Service Technician	Refer to Figure 9 (SIT) or Figure 10 (Honeywell) on page 8 . Remove any surface build-up on pilot and burner assembly. Wipe the pilot nozzles, ignitor/flame rod and hood. Ensure the pilot flame engulfs the flame sensor as shown.
Checking Vent System	Qualified Service Technician	Inspect the vent system at the top and at the base (within the firebox) for signs of blockage or obstruction. Look for any signs of dislocation of the vent components.
Appliance Checkout	Qualified Service Technician	Perform the appropriate appliance checkout procedure detailed in this manual.
Replacing Rockwool Ember Materials	Homeowner/Qualified Services Technician	Remove old ember materials and vacuum the rockwool placement area. Place new rockwool as described in this document.

Periodically (After the Burning Season)

Maintenance Task	Accomplishing Person	Procedure
Cleaning Firebox Interior	Homeowner	Carefully remove logs, rockwool and decorative volcanic stone and vermiculite. Vacuum interior of the firebox. Clean firebox walls and log grate. Replace logs, Rockwool and volcanic stone as detailed in this manual.
Check Flame Patterns and Flame Height	Homeowner	Refer to Refer to Figures 6 (EDV3530), 7 (EDV4035) or 8 (EDV4540) on page 7 and verify the flame pattern and height displayed by the appliance conforms to the picture. Flames must not impinge on the logs.
Checking Vent System	Homeowner	Inspect the vent system at the top and at the base (within the firebox) for signs of blockage or obstruction. Look for any signs of dislocation of the vent components.
Cleaning Front Glass Enclosure Panel	Homeowner	Clean as necessary following the directions provided in this manual. DO NOT TOUCH OR ATTEMPT TO CLEAN GLASS WHILE HOT.

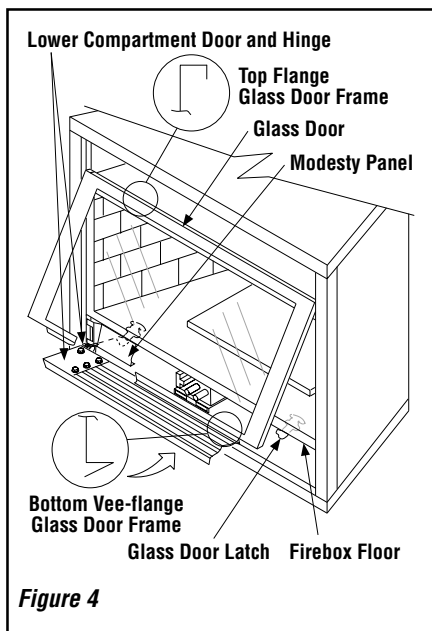

To install the front glass enclosure panel, proceed as follows:

1. Retrieve the glass door frame. Visually inspect the gasket on the backside of the panel. The gasket surface must be clean, free of irregularities and seated firmly.
2. Position the door frame in front of the firebox opening and engage the top flange over the lip at the top of the firebox opening.
3. Swing the door down and back. Ensure the gasket seats evenly as the door draws shut. Engage the Vee-flange at the bottom of the door with the latches and close the latches to secure the door.
4. Reinstall the bottom compartment door by inserting the right side locating pin into the right cabinet corner post and then the left side spring-loaded pin into the left cabinet corner post.
5. Reinstall the top and bottom bustle, and the top louver assembly or radiant panel.

Burner Adjustments

The following paragraphs address burner adjustment concerns and procedures.

Flame Appearance and Sooting

Proper flame appearance is a matter of taste. Generally most people prefer the warm glow of a yellow to orange flame. Appliances operated with air shutter openings that are too large will exhibit flames that are blue and transparent. These weak, blue and transparent flames are termed anemic. If the air shutter opening is too small sooting may develop.

Sooting is indicated by black puffs developing at the tips of very long orange flames. Sooting results in black deposits forming on the logs, appliance inside surfaces and on exterior surfaces adjacent to the vent termination.

Sooting is caused by incomplete combustion in the flames and a lack of combustion air entering the air shutter opening. To achieve a warm yellow to orange flame with an orange body that does not soot, the shutter opening must be adjusted between these two extremes. No smoke or soot should be present. Reposition the logs if the flames impinge on any of them.

If the logs are properly positioned and sooting conditions exist, the air shutter opening on the main burner tube should be adjusted. Normally, the more offsets in the vent system, the greater the need for the air shutter to be opened further.

WARNING: AIR SHUTTER ADJUSTMENT SHOULD ONLY BE PERFORMED BY A QUALIFIED PROFESSIONAL SERVICE TECHNICIAN.

ENSURE THAT THE FRONT GLASS PANEL IS IN PLACE AND SEALED DURING ADJUSTMENT.

Adjustment

CAUTION: THE ADJUSTMENT ROD AND NEARBY APPLIANCE SURFACES ARE HOT. EXERCISE CAUTION TO AVOID INJURY WHILE ADJUSTING FLAME APPEARANCE.

To adjust the flame, move the adjustment rod (located in the lower control area) back or forward to increase or reduce the air shutter opening, respectively. **Position the air shutter to the factory setting as shown in Figure 5 on page 7.** Allow the burner to operate for at least 15 minutes. Observe the flame continuously. If it appears weak or sooty as previously described, adjust the air shutter by pushing or pulling on the adjustment rod until the flame appearance is as desired.

The adjustment rod and associated adjustable air shutter is patented technology. Flame adjustments can be made quickly and accurately to taste without the need of disassembling the appliance and waiting for 30 minutes after each adjustment.

Propane models may exhibit a flame pattern that may candle or appear stringy. If this is problematic or persists as the appliance is continually operated, adjust the air shutter closed as described in the previous paragraphs. Operate the appliance for a period of time as the effect diminishes, ensuring that the appliance does not develop sooty flames.

When satisfied that the appliance operates properly, proceed to finish the installation. Leave the control knob in "ON" position and turn the remote switch "OFF." Close the lower control compartment door.

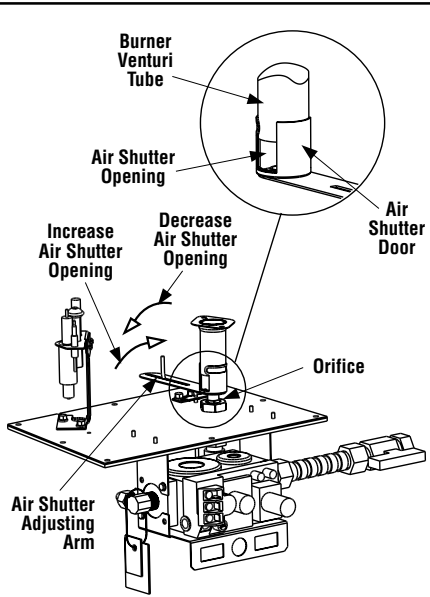

**MAIN BURNER
FACTORY SHUTTER OPENING SETTING**

Models	Natural Gas inches (mm)	Propane Gas inches (mm)
EDV3530	1/8 (3.2)	3/8 (9.5)
EDV4035		3/8 (9.5)
EDV4540		3/8 (9.5)

Figure 5

Log Placement

WARNING: LOGS GET VERY HOT AND WILL REMAIN HOT UP TO ONE HOUR AFTER GAS SUPPLY IS TURNED OFF. HANDLE ONLY WHEN LOGS ARE COOL. TURN OFF ALL ELECTRICITY TO THE APPLIANCE BEFORE YOU INSTALL GRATE AND LOGS.

WARNING: THIS APPLIANCE IS NOT MEANT TO BURN WOOD. ANY ATTEMPT TO DO SO COULD CAUSE IRREPARABLE DAMAGE TO YOUR APPLIANCE AND PROVE HAZARDOUS TO YOUR SAFETY.

WARNING: THE SIZE AND POSITION OF THE LOG SET WAS ENGINEERED TO GIVE YOUR APPLIANCE A SAFE, RELIABLE AND ATTRACTIVE FLAME PATTERN. ANY ATTEMPT TO USE A DIFFERENT LOG SET IN THE FIREPLACE WILL VOID THE WARRANTY AND WILL RESULT IN INCOMPLETE COMBUSTION, SOOTING, AND POOR FLAME QUALITY.

Carefully position the ceramic fiber logs and twigs over the burner as shown in **Figures 6 (EDV3530), 7 (EDV4035) or 8 (EDV4540) on this page. Refer to the detailed log placement instructions provided in the LOG PLACEMENT GUIDE accompanying this document.**

Proper twig placement is critical to prevent sooting. Twigs should be placed in the gaps between the flame peaks and should be positioned so that at no time they impinge the flames.



Figure 6

EDV3530



Figure 7

EDV4035

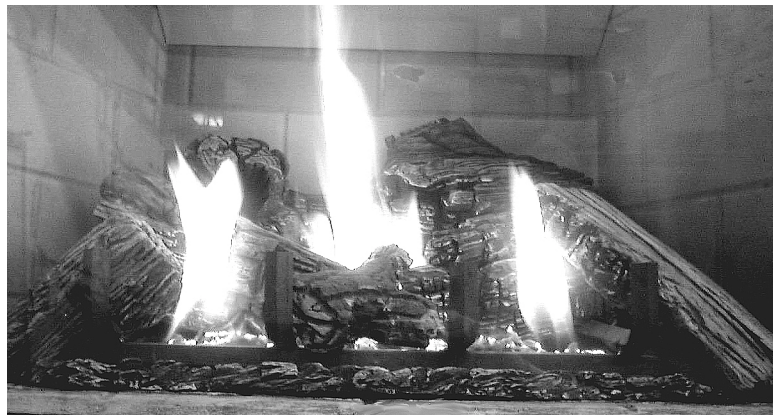

Figure 8

EDV4540

NOTE: DIAGRAMS & ILLUSTRATIONS NOT TO SCALE.

Glowing Embers (Rockwool) Placement

Refer to the detailed glowing embers placement instructions provided in the **LOG PLACEMENT GUIDE** accompanying this document.

Ceramic Panel Placement

Refer to the detailed ceramic panel placement instructions provided in the **LOG PLACEMENT GUIDE** accompanying this document.

Millivolt Appliance Checkout

The pilot flame should be steady, not lifting or floating. Flame should be blue in color with traces of orange at the outer edge.

The top $\frac{3}{8}$ " (10 mm) at the pilot generator (thermopile) and the top $\frac{1}{8}$ " min (tip) of the quick drop out thermocouple should be engulfed in the pilot flame. The flame should project 1" (25 mm) beyond the hood at all three ports. See **Figure 9**. To light the burner, refer to the lighting instructions on **pages 11 and 12**.

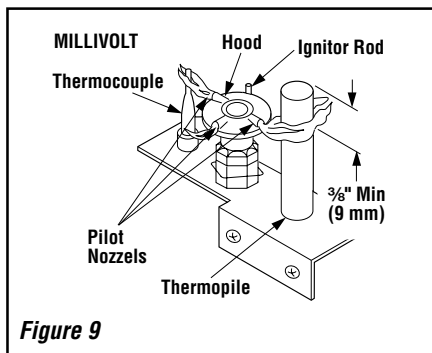

Electronic Appliance Checkout

To light the burner, refer to the lighting instructions on **page 13 and 14**. Ensure the ignitor lights the pilot. The pilot flame should engulf the flame sensor as shown in **Figure 10**.

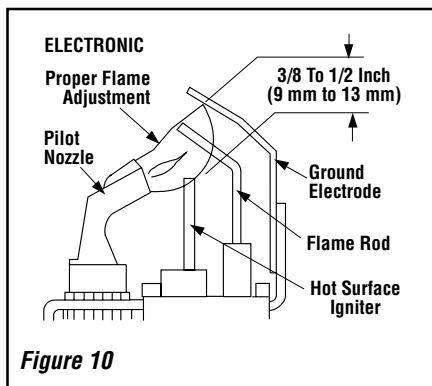

With proper care and maintenance, your appliance will provide many years of enjoyment. If you should experience any problem, first refer to the trouble shooting guide in this manual. If problem persists, contact your Lennox distributor.

ACCESSORY COMPONENTS



Remote Control System (Standard) H0249 RCL

Standard Remote Control System

The Model RCL (Standard) Remote Control System, features a simple On/Off control function for the fireplace. This model includes a hand-held transmitter, a remote receiver with wall-mount coverplate and all hardware required to install the unit. The remote receiver can be wall or hearth mounted.



Flame Modulating Remote Control - Natural Gas H0301 RCL-MN
Flame Modulating Remote Control - LP/Propane Gas H0302 RCL-ML

Flame Modulating Remote Control

Flame Modulating Remote Controls were developed to provide a safe, reliable and user-friendly remote control system for appliances equipped with a Millivolt Gas Valve. A detailed set of instructions are included with each remote.



Remote Control System (Deluxe) H0251 RCL-T

Deluxe Remote Control System

The Model RCL-T (Deluxe) Remote Control System has all of the features of the standard system along with an added easy to read LCD screen which presents access to many enhancements, including; battery power level indicator, timer, mode of operation, thermostatic display including room temperature in either metric of English units, flame indicator and clock. Fully programmable, the Model RCL-T allows for command over nearly all operational and temperature variables, using the hand held remote control transmitter.

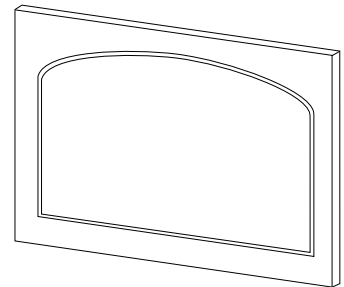

The kits attach to the glass enclosure panel without the use of hardware. The decorative arch kits can **not** be used in conjunction with the screen panel kit.

Arch Door Kits		
Model No.	Catalog No. Model No.	
	Polished Brass	Brushed Stainless
EDV3530	81L34	98L68
	ADK35CPB	ADK35CBS
EDV4035	81L35	98L69
	ADK40CPB	ADK40CBS
EDV4540	81L36	98L70
	ADK45CPB	ADK45CBS

ACCESSORY COMPONENTS CONTINUED

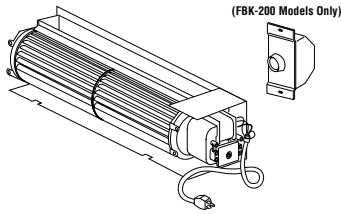

Forced Air Blower Kits		
-Single Speed	80L84	FBK-100
-Variable Speed with wall-mountable switch	80L85	FBK-200
-Variable Speed with unit-mountable switch	80L86	FBK-250

Forced Air Kit

The FBK-100 blower provides constant velocity forced air circulation. The FBK-200 assembly with variable speed, wall-mountable switch provides variable speed forced air circulation. The FBK-250 assembly with variable speed unit-mountable switch, also provides variable speed forced air circulation.

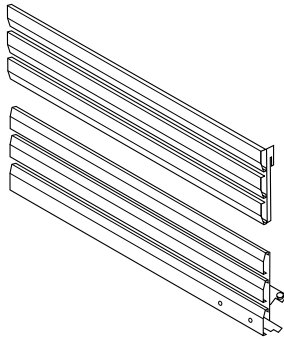

Model No.	Catalog No. Model No.	
	Polished Brass	Brushed Stainless
EDV3530	88L28	88L32
	LVR35PB-2	LVR35BS
EDV4035	88L29	88L33
	LVR40PB-2	LVR40BS
EDV4540	88L30	88L34
	LVR45PB-2	LVR45BS

These louvers are designed to replace the standard charcoal louvers that are provided with the appliance. The brass and brushed stainless louver kits include six (6) louvers.

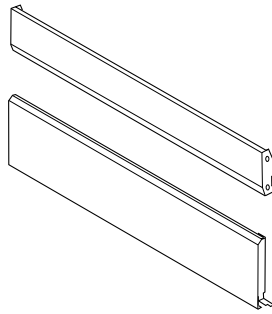

Clean Face Panel Kits	
Model No.	Catalog No. Model No.
EDV3530	88L36 RAD35C-2
	88L37 RAD40C-2
EDV4035	88L38 RAD45C-2
	88L39 RAD45C-2

Clean faced panel kits are available to convert the standard louvered fireplaces to radiant models which are more suited for finishing around the firebox opening with non-combustible materials, such as tile.

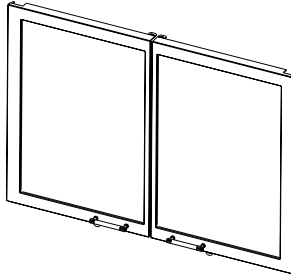

Twin-Pane Door Trim Kits		
Model No.	Catalog No. Model No.	
	Polished Brass	Brushed Stainless
EDV3530	20M82	20M85
	TPDK-35PB	TPDK-35BS
EDV4035	20M83	20M86
	TPDK-40PB	TPDK-40BS
EDV4540	20M84	20M87
	TPDK-45PB	TPDK-45BS

These kits are easy to install and do not require hardware to attach them to the standard glass door frame. They can **not** be used in conjunction with the screen panel kit.

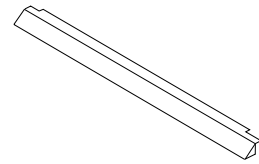

Hood Kits		
Model No.	Catalog No. Model No.	
	Polished Brass	Brushed Stainless
EDV3530	96K67	88L49
	EB35PB	EB35BS
EDV4035	96K68	88L50
	EB40PB	EB40BS
EDV4540	96K69	88L51
	EB45PB	EB45BS

These hood kits replace the standard hood that comes with these fireplaces.

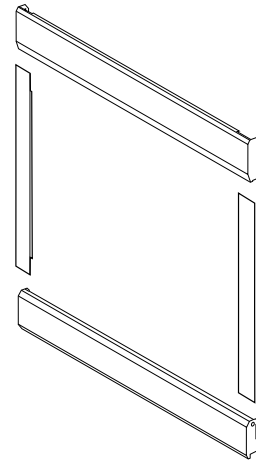

4-Piece Door Frame Kits		
Model No.	Catalog No. Model No.	
	Polished Brass	Brushed Stainless
EDV3530	88L44	90L70
	DTKE35PB	DTKE35BS
EDV4035	88L45	90L71
	DTK40PB-2	DTK40BS
EDV4540	88L46	90L72
	DTK45PB-2	DTK45BS

These kits are designed to attach directly to the front face of the fireplace at the four edges of the glass enclosure panel.

ACCESSORY COMPONENTS CONTINUED

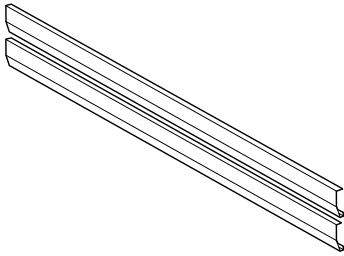

2-Piece Louver Kits		
Model No.	Catalog No. Model No.	
	Polished Brass	Brushed Stainless
EDV3530	96L05	96L09
	2LVR35PB	2LVR35BS
EDV4035	96L06	96L10
	2LVR40PB	2LVR40BS
EDV4540	96L07	96L11
	2LVR45PB	2LVR45BS

The 2-piece polished brass or brushed stainless louver kits may be used to replace either the middle charcoal louver of each louver set, or the charcoal louver in each louver set closest to the glass door.

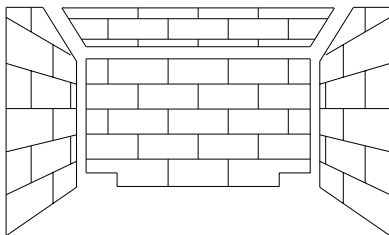

Brickaded Panel Liner Kits	
Model No.	Catalog No. Model No.
EDV3530	H0775 EBLK-35
	H0776 EBLK-40
EDV4540	H0777 EBLK-45

The brickaded panel liner kits include ceramic panels of the side walls, the rear and the baffle of the firebox. The panels have brick-like features in relief.

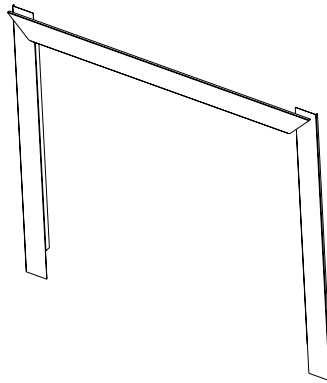

Finish Trim Kits	
Model No.	Catalog No. Model No.
	Polished Brass
EDV3530	H0454 TK35EPB3
	96K22 TK40PB3
EDV4035	96K23 TK45PB3

This kit contains brass trim pieces used to finish the gaps between the wall board and the fireplace, providing the appliance a brass perimeter highlight.

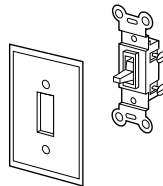

ON/OFF Wall Switch Kit 85L87 FWSK

ON/OFF Wall Switch Kit

The ON/OFF wall switch kit may be used to control the operation of the fireplace burner as an alternative to the modesty panel mounted ON-OFF switch. Install the ON/OFF wall switch in a convenient location near the fireplace.

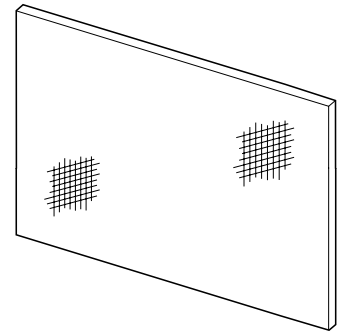

Screen Panel Kits	
Model No.	Catalog No. Model No.
EDV3530	88L52 HG35E
	96K32 HG40
EDV4540	96K33 HG45

These screen panels can be installed on the glass enclosure panel to provide protection from the hot glass surface. The screen panel kits cannot be used in conjunction with either of the arch door kits or door frame kits.



Bag of Glowing Embers 88L53 FGE

Bag of Glowing Embers

Replacement ember materials are available for use with these appliances. Order a bag of Glowing Embers, Model FGE to replace ember materials as part of the periodic maintenance of the appliance.



Touch-Up Paint (Charcoal) Kit 90L74 TPK-C
Touch-Up Paint (Tan) Kit 98K67 TPK-T

Touch-Up Paint Kit

Repair of minor scratches and discoloration of the appliance charcoal painted surfaces may be accomplished with the touch-up paint kit.

ACCESSORY COMPONENTS CONTINUED

Style View Doors -

Style View Doors come in 4 beautiful styles. They are easy to install and will not require hardware to attach them to the standard glass door frame. The door includes heavy duty magnet door latches and functional twin-pane doors.

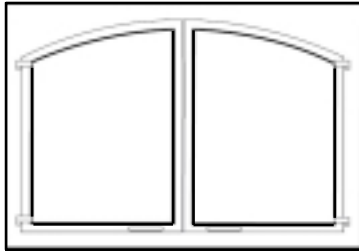

Arch Design

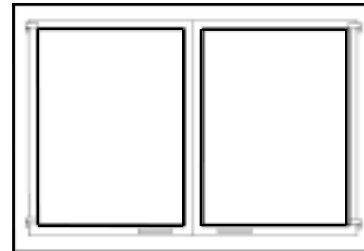

Square Design

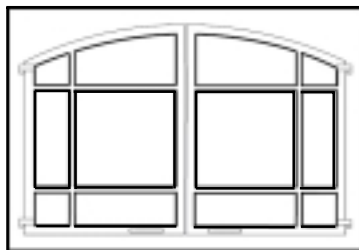

Arch Pane Design

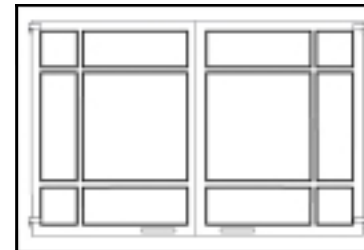

Square Pane Design

ARCH DESIGN KITS			
Cat. No.	Model	Description	Model Series
H0862	AD40C	40" Arch Doors, Charcoal	EDV4035
H0863	AD40TI	40" Arch Doors, Textured Iron	
H0864	AD40SP	40" Arch Doors, Satin Pewter	
H0865	AD40AB	40" Arch Doors, Antique Brass	
H0866	AD45C	45" Arch Doors, Charcoal	EDV4540
H0867	AD45TI	45" Arch Doors, Textured Iron	
H0868	AD45SP	45" Arch Doors, Satin Pewter	
H0869	AD45AB	45" Arch Doors, Antique Brass	
H0870	AD35EC	35" Elite Arch Doors, Charcoal	EDV3530
H0871	AD35ETI	35" Elite Arch Doors, Textured Iron	
H0872	AD35ESP	35" Elite Arch Doors, Satin Pewter	
H0873	AD35EAB	35" Elite Arch Doors, Antique Brass	
ARCH PANE DESIGN KITS			
H0934	APD40C	40" Arch Pane Doors, Charcoal	EDV4035
H0935	APD40TI	40" Arch Pane Doors, Textured Iron	
H0936	APD40SP	40" Arch Pane Doors, Satin Pewter	
H0937	APD40AB	40" Arch Pane Doors, Antique Brass	
H0938	APD45C	45" Arch Pane Doors, Charcoal	EDV4540
H0939	APD45TI	45" Arch Pane Doors, Textured Iron	
H0940	APD45SP	45" Arch Pane Doors, Satin Pewter	
H0941	APD45AB	45" Arch Pane Doors, Antique Brass	
H0942	APD35EC	35" Elite Arch Pane Doors, Charcoal	EDV3530
H0943	APD35ETI	35" Elite Arch Pane Doors, Textured Iron	
H0944	APD35ESP	35" Elite Arch Pane Doors, Satin Pewter	
H0945	APD35EAB	35" Elite Arch Pane Doors, Antique Brass	

SQUARE DESIGN KITS			
Cat. No.	Model	Description	Model Series
H0950	SD40C	40" Sq. Doors, Charcoal	EDV4035
H0951	SD40TI	40" Sq. Doors, Textured Iron	
H0952	SD40SP	40" Sq. Doors, Satin Pewter	
H0953	SD40AB	40" Sq. Doors, Antique Brass	
H0954	SD45C	45" Sq. Doors, Charcoal	EDV4540
H0955	SD45TI	45" Sq. Doors, Textured Iron	
H0956	SD45SP	45" Sq. Doors, Satin Pewter	
H0957	SD45AB	45" Sq. Doors, Antique Brass	
H0958	SD35EC	35" Elite Sq. Doors, Charcoal	EDV3530
H0959	SD35ETI	35" Elite Sq. Doors, Textured Iron	
H0960	SD35ESP	35" Elite Sq. Doors, Satin Pewter	
H0961	SD35EAB	35" Elite Sq. Doors, Antique Brass	
SQUARE PANE DESIGN KITS			
H0966	SPD40C	40" Sq. Pane Doors, Charcoal	EDV4035
H0967	SPD40TI	40" Sq. Pane Doors, Textured Iron	
H0968	SPD40SP	40" Sq. Pane Doors, Satin Pewter	
H0969	SPD40AB	40" Sq. Pane Doors, Antique Brass	
H0970	SPD45C	45" Sq. Pane Doors, Charcoal	EDV4540
H0971	SPD45TI	45" Sq. Pane Doors, Textured Iron	
H0972	SPD45SP	45" Sq. Pane Doors, Satin Pewter	
H0973	SPD45AB	45" Sq. Pane Doors, Antique Brass	
H0974	SPD35EC	35" Elite Sq. Pane Doors, Charcoal	EDV3530
H0975	SPD35ETI	35i Elite Sq. Pane Doors, Textured Iron	
H0976	SPD35ESP	35" Elite Sq. Pane Doors, Satin Pewt.	
H0977	SPD35EAB	35" Elite Sq. Pane Doors, Ant. Brass	

ACCESSORY COMPONENTS CONTINUED

Style View Doors Continued -

Style View Doors also come in a Tall Arch Pane Design. Two distinctive grille kits, the “Crescents” and “Sunrise” design, are also offered separately. They are easy to install and will not require hardware to attach them to the standard glass door frame. The door includes heavy duty magnet door latches and functional twin-pane doors.

Tall Arch Pane Door

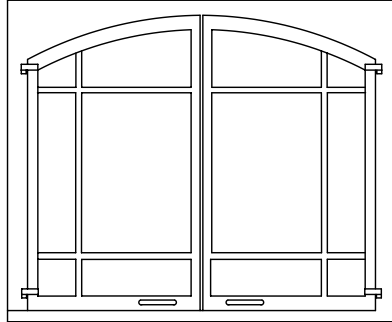

TALL ARCH PANE DOORS			
Cat. No.	Model	Description	Model Series
H3537	TAPD35EC	35" Elite Arch Pane Doors, Charcoal	EDV3530
H3539	TAPD35ESP	35" Elite Arch Pane Doors, Satin Pewter	
H3529	TAPD40C	40" Arch Pane Doors, Charcoal	EDV4035
H3531	TAPD40SP	40" Arch Pane Doors, Satin Pewter	
H3533	TAPD45C	45" Arch Pane Doors, Charcoal	EDV4540
H3535	TAPD45SP	45" Arch Pane Doors, Satin Pewter	

“Crescents” Grille Kits

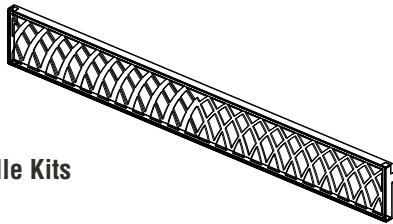

“Sunrise” Grille Kits

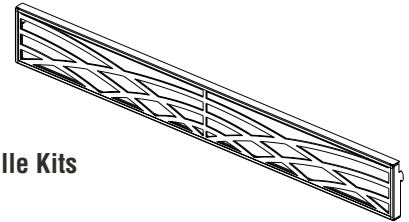

“Crescents” Grille Kits			
Cat. No.	Model	Description	Model Series
H3541	CUGK35C	35" Crescents Upper Grille Kit, Charcoal	EDV3530
H3543	CUGK35SP	35" Crescents Upper Grille Kit, Satin Pewter	
H3545	CLGK35C	35" Crescents Lower Grille Kit, Charcoal	
H3547	CLGK35SP	35" Crescents Lower Grille Kit, Satin Pewter	
H3549	CUGK40C	40" Crescents Upper Grille Kit, Charcoal	EDV4035
H3551	CUGK40SP	40" Crescents Upper Grille Kit, Satin Pewter	
H3553	CLGK40C	40" Crescents Lower Grille Kit, Charcoal	
H3555	CLGK40SP	40" Crescents Lower Grille Kit, Satin Pewter	
H3557	CUGK45C	45" Crescents Upper Grille Kit, Charcoal	EDV4540
H3559	CUGK45SP	45" Crescents Upper Grille Kit, Satin Pewter	
H3561	CLGK45C	45" Crescents Lower Grille Kit, Charcoal	
H3563	CLGK45SP	45" Crescents Lower Grille Kit, Satin Pewter	

“Sunrise” Grille Kits			
Cat. No.	Model	Description	Model Series
H3565	SUGK35C	35" Sunrise Upper Grille Kit, Charcoal	EDV3530
H3567	SUGK35SP	35" Sunrise Upper Grille Kit, Satin Pewter	
H3569	SLGK35C	35" Sunrise Lower Grille Kit, Charcoal	
H3571	SLGK35SP	35" Sunrise Lower Grille Kit, Satin Pewter	
H3573	SUGK40C	40" Sunrise Upper Grille Kit, Charcoal	EDV4035
H3575	SUGK40SP	40" Sunrise Upper Grille Kit, Satin Pewter	
H3577	SLGK40C	40" Sunrise Lower Grille Kit, Charcoal	
H3579	SLGK40SP	40" Sunrise Lower Grille Kit, Satin Pewter	
H3581	SUGK45C	45" Sunrise Upper Grille Kit, Charcoal	EDV4540
H3583	SUGK45SP	45" Sunrise Upper Grille Kit, Satin Pewter	
H3585	SLGK45C	45" Sunrise Lower Grille Kit, Charcoal	
H3587	SLGK45SP	45" Sunrise Lower Grille Kit, Satin Pewter	

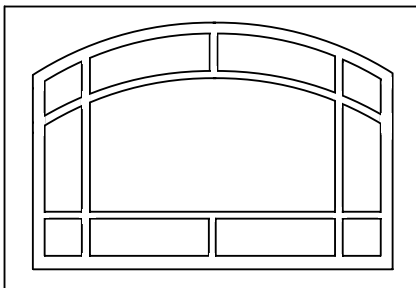

Arch Screen Panel Kit
40" Decorative Arch Screen Panel Kit - Textured Iron

Model No.
DASPK40TI

Catalog No.
H3594

This screen panel kit can be installed on the glass enclosure panel to prevent direct contact with the hot glass surface. The panel kit adds a new design choice with a handsome textured iron finish. The screen panel kit cannot be used in conjunction with either of the arch door kits or door frame kits.

WIRING DIAGRAMS

Wiring diagrams are provided here for reference purposes only. This information is also provided on schematics attached directly to the appliance on a pullout panel located within the control compartment.

CAUTION: LABEL ALL WIRES PRIOR TO DISCONNECTION WHEN SERVICING CONTROLS. WIRING ERRORS CAN CAUSE IMPROPER AND DANGEROUS APPLIANCE OPERATION.

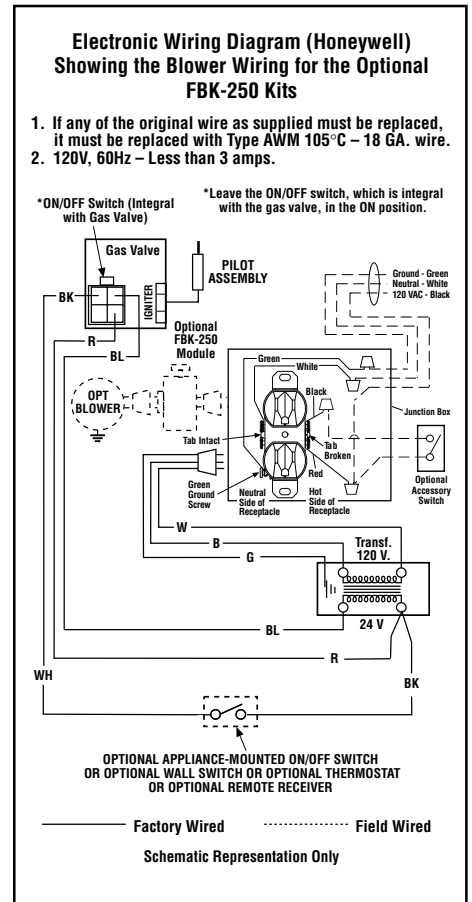
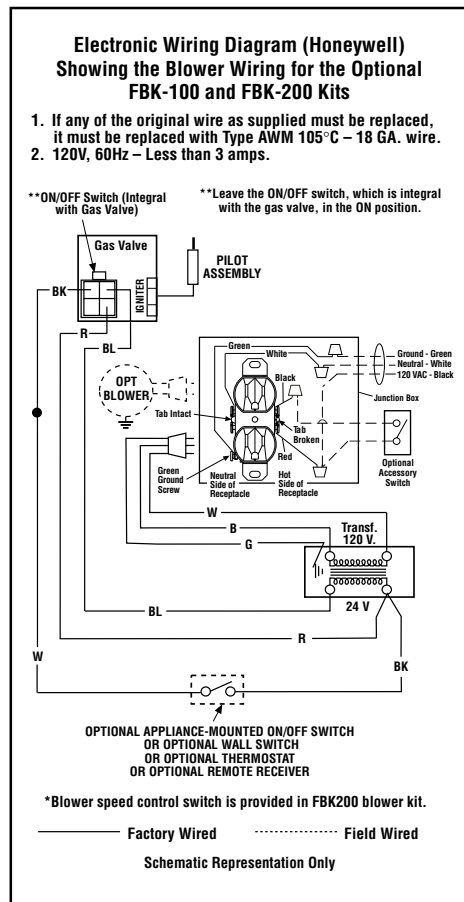
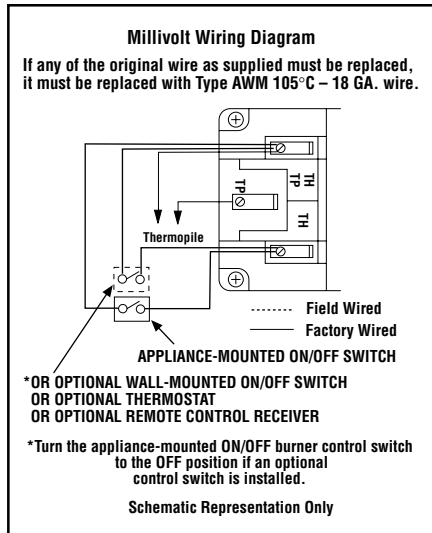

WARRANTY

Your gas appliance is covered by a limited twenty year warranty. You will find a copy of the warranty accompanying this manual. Please read the warranty to be familiar with its coverage.

Retain this manual. File it with your other documents for future reference.

PRODUCT REFERENCE INFORMATION

We recommend that you record the following important information about your fireplace. Please contact your Lennox dealer for any questions or concerns. For the number of your nearest Lennox dealer, please call 1-800-9-LENNOX.

Your Fireplace's Model Number _____

Your Fireplace's Serial Number _____

The Date On Which Your Fireplace Was Installed _____

The Type of Gas Your Fireplace Uses _____

Your Dealer's Name _____

REPLACEMENT PARTS

A complete parts list is found at the end of this manual. Use only parts supplied from the manufacturer.

Normally, all parts should be ordered through your Lennox distributor or dealer. Parts will be shipped at prevailing prices at time of order.

When ordering repair parts, always give the following information:

- The model number of the appliance.
- The serial number of the appliance.
- The part number.
- The description of the part.
- The quantity required.
- The installation date of the appliance.

If you encounter any problems or have any questions concerning the installation or application of this system, please contact your distributor, or Lennox directly:

LENNOX HEARTH PRODUCTS
1110 West Taft Avenue
Orange, CA 92865

NOTES:



LIGHTING INSTRUCTIONS – MILLIVOLT GAS VALVE

FOR YOUR SAFETY READ BEFORE LIGHTING

WARNING: IF YOU DO NOT FOLLOW THESE INSTRUCTIONS EXACTLY, A FIRE OR EXPLOSION MAY RESULT CAUSING PROPERTY DAMAGE, PERSONAL INJURY OR LOSS OF LIFE.

- A.** This appliance has a pilot which must be lighted with a piezo ignitor. When lighting the pilot, follow these instructions exactly.
- B. BEFORE OPERATING** smell all around the appliance area for gas. Be sure to smell next to the floor because some gas is heavier than air and will settle on the floor.
- WHAT TO DO IF YOU SMELL GAS**
- Extinguish any open flame.
 - Open windows.
 - Do not light any appliance.
 - Do not touch any electrical switches.
 - Do not use any phone in your building.
 - Immediately call your gas supplier from a neighbor's phone.
 - If your gas supplier cannot be reached, call the fire department.
- C.** Use only your hand to push in or turn the gas control knob. Never use tools. If the knob will not push in or turn by hand, do not try to repair it, call a qualified service technician. Force or attempted repair may result in a fire or an explosion.
- D.** Do not use this appliance if any part has been under water. Immediately call a qualified service technician to inspect the appliance and to replace any part of the control system and any gas control which has been under water.

LIGHTING INSTRUCTIONS

1. **STOP!** Read the safety information above on this page.
2. Access the lower control compartment.
3. Turn remote wall switch to "OFF."
4. Verify main line shut-off valve is open.
5. Push in gas control knob slightly and turn clockwise to "OFF."

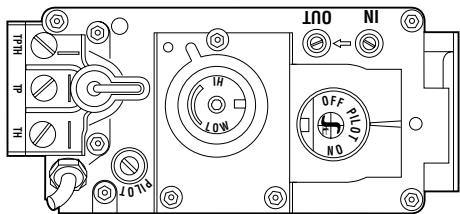
6. Wait five (5) minutes to clear out any gas. If you then smell gas, STOP! Follow "B" in the safety information above on this page. If you do not smell gas, go to the next step.
7. Push in gas control knob slightly and turn counterclockwise to "PILOT."

8. Push in control knob all the way and hold in. Immediately light the pilot by triggering the spark ignitor (pushing the button) until pilot lights. Continue to hold the control knob in for about 1 1/2 minutes after the pilot is lit. Release knob and it will pop back up. Pilot should remain lit. If it goes out, repeat steps 5 through 8.

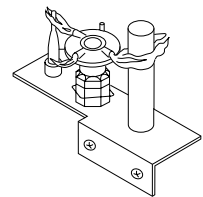

Note: Knob cannot be turned from "PILOT" to "OFF" unless the knob is pushed in slightly. Do not force.

- If knob does not pop up when released, stop and immediately call your service technician or gas supplier.
- If pilot will not stay lit after several tries, turn the control knob to "OFF" and call your service technician or gas supplier.



9. Turn gas control knob counterclockwise to "ON."

10. Close lower control compartment.

TO TURN OFF GAS TO APPLIANCE

1. Turn remote wall switch "OFF." The pilot will remain lit for normal service.
2. For complete shutdown, turn remote wall switch to "OFF."
3. Access the lower control compartment.
4. Depress gas control knob slightly and turn clockwise to "OFF." Do not force.

5. Close lower control compartment.

INSTRUCTIONS D'ALLUMAGE – VANNE GAZ MILLIVOLT

POUR VOTRE SÉCURITÉ, LISEZ CES INSTRUCTIONS AVANT L'ALLUMAGE

AVERTISSEMENT : SI VOUS NE SUIVEZ PAS CES INSTRUCTIONS À LA LETTRE, IL POURRAIT S'EN SUIVRE UN INCENDIE OU UNE EXPLOSION CAUSANT DES DOMMAGES MATÉRIELS, DES BLESSURES CORPORELLES OU MÊME DES PERTES DE VIE.

- A.** Cet appareil est muni d'une veilleuse qui doit être allumée avec un allumeur piézo-électrique. Lorsque vous allumez la veilleuse, suivre exactement ces instructions.
- B. AVANT L'ALLUMAGE:** Assurez-vous que vous ne détectez aucune odeur de gaz autour de l'appareil ainsi que près du sol; certains gaz, étant plus lourds que l'air, descendent au niveau du sol.
VOICI CE QUE VOUS DEVEZ FAIRE SI VOUS DÉCELEZ UNE ODEUR DE GAZ:
- Éteignez toute flamme visible.
 - Ouvrez les fenêtres.
 - N'allumez aucun appareil.
 - Ne touchez à aucun commutateur électrique.
 - Ne vous servez d'aucun téléphone dans votre édifice.
- Appelez immédiatement votre compagnie de gaz en utilisant le téléphone du voisin.
 - S'il vous est impossible de contacter votre compagnie de gaz, appelez le service des incendies.
- C.** N'utilisez que votre main pour manipuler le bouton de réglage du gaz. N'utilisez jamais d'outils. Si le bouton refuse de tourner ou de bouger, n'essayez pas de le réparer. Communiquez immédiatement avec un technicien de service qualifié. Toute tentative pour le forcer ou le réparer, risquerait de provoquer un incendie ou une explosion.
- D.** Ne vous servez pas de cet appareil si l'un de ses éléments a été immergé dans l'eau. Appelez immédiatement un technicien compétent pour faire inspecter l'appareil et remplacer toute pièce du système de réglage ou commande du gaz qui a été sous l'eau.

INSTRUCTIONS D'ALLUMAGE

- 1. ARRÊTEZ!** Lisez les consignes de sécurité au verso de cette plaque.
- Ouvrez le compartiment de contrôle du bas.
- Tournez l'interrupteur mural à la position d'arrêt "OFF".
- Assurez-vous que la soupape d'arrêt de la canalisation principale est ouverte.
- Enfoncez légèrement le bouton de réglage du gaz et tournez-le dans le sens des aiguilles d'une montre jusqu'à la position d'arrêt "OFF".

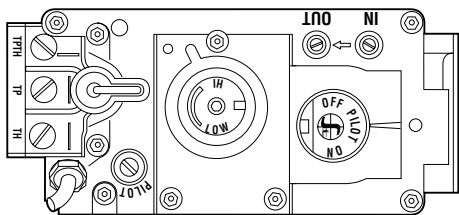

Remarque: Il est impossible de tourner le bouton de "PILOT" à "OFF" à moins qu'il ne soit légèrement enfoncé. Ne le forcez pas.

- 6.** Attendez cinq (5) minutes pour l'évacuation du gaz. Si vous décelez une odeur de gaz, ARRÊTEZ ! Retournez au point "B" des consignes de sécurité au verso de cette plaque. Si vous ne remarquez aucune odeur de gaz, passez à l'étape suivante.
- 7.** Enfoncez légèrement le bouton de réglage du gaz et tournez-le en sens inverse des aiguilles d'une montre jusqu'à la position de veilleuse "PILOT".

- 8.** Enfoncez le bouton de réglage jusqu'au fond et gardez-le enfoncé. Allumez immédiatement la veilleuse en déclenchant l'allume-gaz à étincelle (en poussant le bouton) jusqu'à ce que la veilleuse s'enflamme. Continuez de tenir le bouton de réglage enfoncé pendant environ 90 secondes après l'allumage de la veilleuse. Relâchez le bouton et il sortira subitement. La veilleuse devrait rester allumée. Si elle s'éteint, répétez les étapes 5 à 8 inclusivement.

- Si le bouton ne sort pas automatiquement après avoir été relâché, arrêtez immédiatement et téléphonez à votre technicien de service ou à votre fournisseur de gaz.

- Si la veilleuse refuse de rester allumée après plusieurs tentatives, tournez le bouton de réglage jusqu'à sa position d'arrêt "OFF" et téléphonez à votre technicien de service ou à votre fournisseur de gaz.

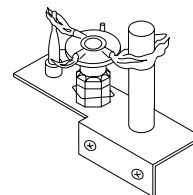

- 9.** Tournez le bouton de réglage du gaz en sens inverse des aiguilles d'une montre jusqu'à sa position de marche "ON".
- 10.** Fermez le compartiment de contrôle du bas.
- 11.** Au besoin, rebrancher l'appareil au courant électrique et remettre l'interrupteur du brûleur principal à la position "ON" ou régler le thermostat à la température désirée.
- 12.** Si l'appareil ne fonctionne pas, suivre les instructions intitulées "Pour fermer le gaz qui alimente l'appareil" et appeler un technicien ou le fournisseur de gaz.

POUR FERMER LE GAZ QUI ALIMENTE L'APPAREIL

- 1.** Tournez l'interrupteur mural à la position d'arrêt "OFF". La veilleuse restera allumée jusqu'au retour du service normal.
- 2.** Pour une fermeture complète, tournez l'interrupteur mural à la position d'arrêt "OFF".
- 3.** Ouvrez le compartiment de contrôle du bas.
- 4.** Enfoncez légèrement le bouton de réglage du gaz et tournez-le dans le sens des aiguilles d'une montre jusqu'à la position d'arrêt "OFF". Ne forcez pas le bouton.
- 5.** Fermez le compartiment de contrôle du bas.

LIGHTING INSTRUCTIONS — ELECTRONIC

FOR YOUR SAFETY READ BEFORE LIGHTING

WARNING: IF YOU DO NOT FOLLOW THESE INSTRUCTIONS EXACTLY, A FIRE OR EXPLOSION MAY RESULT CAUSING PROPERTY DAMAGE, PERSONAL INJURY OR LOSS OF LIFE.

- A.** When lighting the appliance, follow these instructions exactly.
- B. BEFORE OPERATING** smell all around the appliance area for gas. Be sure to smell next to the floor because some gas is heavier than air and will settle on the floor.
- WHAT TO DO IF YOU SMELL GAS**
- Extinguish any open flame.
 - Open windows.
 - Do not light any appliance.
 - Do not touch any electrical switches.
 - Do not use any phone in your building.
- Immediately call your gas supplier from a neighbor's phone.
 - If your gas supplier cannot be reached, call the fire department.
- C.** Use only your hand to turn the gas control lever. Never use tools. If the lever will not turn by hand, do not try to repair it, call a qualified service technician. Force or attempted repair may result in a fire or an explosion.
- D.** Do not use this appliance if any part has been under water. Immediately call a qualified service technician to inspect the appliance and to replace any part of the control system and any gas control which has been under water.

LIGHTING INSTRUCTIONS

1. **STOP!** Read the safety information above on this page.
2. Turn remote wall switch to "OFF."
3. Open lower control compartment door.
4. Verify main line shut-off valve is open.
5. Turn the ON/OFF switch to "OFF". Do not force.
6. Wait five (5) minutes to clear out any gas. If you then smell gas, STOP! Follow "B" in the safety information above on this page. If you do not smell gas, go to the next step.
7. Turn the ON/OFF switch to "ON". Do not force.
8. Turn "ON" all electrical power to appliance (remote wall switch).
9. Close lower control compartment door.

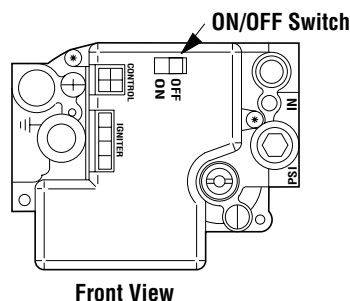

TO SHUT OFF

1. Turn off all electrical power to the appliance (remote wall switch).

TO TURN OFF GAS TO APPLIANCE

1. For complete shut-down, turn remote wall switch to "OFF."
2. Open lower control compartment door.
3. Turn the ON/OFF switch to "OFF". Do not force.
4. Close the main line shut-off valve.
5. Close lower control compartment door.

INSTRUCTIONS D'ALLUMAGE — ELECTRONIC

POUR VOTRE SÉCURITÉ, LISEZ CES INSTRUCTIONS AVANT L'ALLUMAGE

AVERTISSEMENT: SI VOUS NE SUIVEZ PAS CES INSTRUCTIONS À LA LETTRE, IL POURRAIT S'EN SUIVRE UN INCENDIE OU UNE EXPLOSION CAUSANT DES DOMMAGES MATÉRIELS, DES BLESSURES CORPORELLES OU MÊME DES PERTES DE VIE.

- A.** Lorsque vous allumez l'appareil, suivez exactement ces instructions.
- B. AVANT L'ALLUMAGE:** Assurez-vous que vous ne détectez aucune odeur de gaz autour de l'appareil ainsi que près du sol; certains gaz, étant plus lourds que l'air, descendent au niveau du sol.
- VOICI CE QUE VOUS DEVEZ FAIRE SI VOUS DÉCELEZ UNE ODEUR DE GAZ**
- Éteignez toute flamme visible.
 - Ouvrez les fenêtres.
 - N'allumez aucun appareil.
 - Ne touchez à aucun commutateur électrique.
 - Ne vous servez d'aucun téléphone dans votre édifice.
- C.** N'utilisez que votre main pour manipuler l'interrupteur "ON/OFF" de la valve à gaz. N'utilisez jamais d'outils. Si l'interrupteur ne bouge pas manuellement, n'essayez pas de le réparer. Communiquez immédiatement avec un technicien de service qualifié. Toute tentative pour forcer l'interrupteur ou le réparer, risquerait de provoquer un incendie ou une explosion.
- D.** Ne vous servez pas de cet appareil si l'un de ses éléments a été immergé dans l'eau. Appelez immédiatement un technicien compétent pour faire inspecter l'appareil et remplacer toute pièce du système de réglage ou commande du gaz qui a été sous l'eau.
- E.** Appelez immédiatement votre compagnie de gaz en utilisant le téléphone du voisin.
- F.** S'il vous est impossible de contacter votre compagnie de gaz, appelez le service des incendies.

INSTRUCTIONS D'ALLUMAGE

- 1. ARRÊTEZ !** Lisez les consignes de sécurité au verso de cette plaque.
2. Tournez l'interrupteur mural à la position d'arrêt "OFF".
3. Ouvrez la porte du compartiment de contrôle du bas.
4. Assurez-vous que la soupape d'arrêt de la canalisation principale est ouverte.
5. Tournez la manette de réglage du gaz à la position d'arrêt "OFF".
6. Attendez cinq (5) minutes pour l'évacuation du gaz. Si vous décelez une odeur de gaz ARRÊTEZ ! Retournez au point "B" des consignes de sécurité au verso de cette plaque. Si vous ne remarquez aucune odeur de gaz, passez à l'étape suivante.
7. Tournez la manette de réglage du gaz jusqu'à la position de marche "ON". Ne la forcez pas.
8. Ouvrez le courant électrique ("ON") qui alimente l'appareil (interrupteur mural).
9. Fermez la porte du compartiment de contrôle du bas.
10. Au besoin, rebrancher l'appareil au courant électrique et remettre l'interrupteur principal du brûleur à la position "ON" ou régler le thermostat à la température désirée.
11. Si l'appareil ne se met pas en marche, suivre les instructions intitulées "Pour fermer le gaz qui alimente l'appareil" et appeler un technicien ou le fournisseur de gaz.

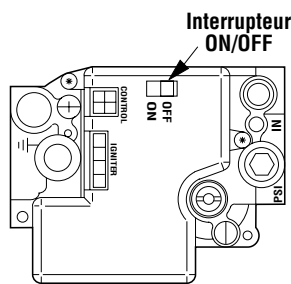

Vue de face

POUR ÉTEINDRE L'APPAREIL

1. Coupez tout le courant électrique qui alimente l'appareil (interrupteur mural).

POUR FERMER LE GAZ QUI ALIMENTE L'APPAREIL

1. Pour une fermeture complète, tournez l'interrupteur mural à la position d'arrêt "OFF".
2. Ouvrez la porte du compartiment de contrôle du bas.
3. Tournez la manette de réglage du gaz à la position d'arrêt "OFF". Ne la forcez pas.
4. Fermez la soupape d'arrêt de la canalisation principale.
5. Fermez la porte du compartiment de contrôle du bas.

TROUBLESHOOTING THE MILLIVOLT GAS CONTROL SYSTEM

Note: Before troubleshooting the gas control system, be sure external gas shut off valve (located at gas supply inlet) is in the "ON" position.

Important: Valve system troubleshooting should only be accomplished by a qualified service technician.

SYMPTOM	POSSIBLE CAUSES	CORRECTIVE ACTION
1. Spark ignitor will not light pilot after repeated triggering of ignitor button.	A. Defective ignitor (no spark at electrode).	Check for spark at electrode and pilot; if no spark and electrode wire is properly connected, replace ignitor.
	B. Defective or misaligned electrode at pilot (spark at electrode).	Using a match, light pilot. If pilot lights, turn off pilot and trigger the ignitor button again. If pilot lights, an improper gas mixture caused the bad lighting and a longer purge period is recommended. If pilot will not light – check gap at electrode and pilot – should be 1/8" to have a strong spark. If gap measures 1/8", replace pilot (Figure 9 on page 8).
	C. Gas supply pressure errant.	Check inlet gas pressure. It should be within the limits as marked on the rating plate.
	D. Pilot orifice plugged.	Clean or replace pilot orifice.
2. Pilot will not stay lit after carefully following the lighting instructions.	A. Defective pilot generator (thermocouple).	Check pilot flame, it must impinge on thermocouple (Figure 9 on page 8) Clean and/or adjust pilot for maximum flame impingement on thermocouple. Ensure that the connection between the valve and thermocouple are tight and secure.
3. Pilot burning, no gas to burner, Valve knob "ON," Wall Switch "ON."	A. Wall switch or wires defective.	Check wall switch and wires for proper connections. Jumper wire across terminals at wall switch, if burner comes on, replace defective wall switch. If okay, jumper wires across wall switch wires at valve, if burner comes on, wires are faulty or connections are bad.
	B. Thermopile may not be generating sufficient millivoltage.	Check thermopile with millivolt meter. Take reading at thermopile terminals of gas valve. Should read 325 millivolts minimum with optional wall switch "OFF." Replace faulty thermopile if reading is below specified minimum.
	C. Plugged burner orifice.	Check burner orifice for stoppage and remove.
4. Frequent pilot/burner outage problem.	A. Pilot flame may be too low or blowing (high) causing the pilot/valve safety to drop out.	Clean and/or adjust pilot flame for maximum flame impingement on thermocouple (Figure 9 on page 8).

TROUBLESHOOTING THE ELECTRONIC IGNITION SYSTEM

Note: Before troubleshooting, be sure that the appliance main line gas shut-off valve, the gas control valve and the wall switch are in the "ON" position.

Important: Valve system troubleshooting should only be accomplished by a qualified service technician.

SYMPTOM	POSSIBLE CAUSES	CORRECTIVE ACTION
1. Burner will not light.	A. Faulty Valve System.	See Below.
	B. "OFF/ON" or wall switch defective.	Disconnect the two black wires from the wire nuts. Test switch(s) for continuity with a multimeter. If continuity is not indicated, switch(s) is defective and must be replaced. <i>Note: Before replacing "OFF/ON" switch, be sure to check wiring for loose connections or broken wires and repair as needed.</i>
2. Burners come "ON" but go "OFF."	A. Burner orifice plugged.	Check main burner orifice(s) for stoppage. Clean or replace.
	B. Obstructed vent system.	Check vent system for obstructions.

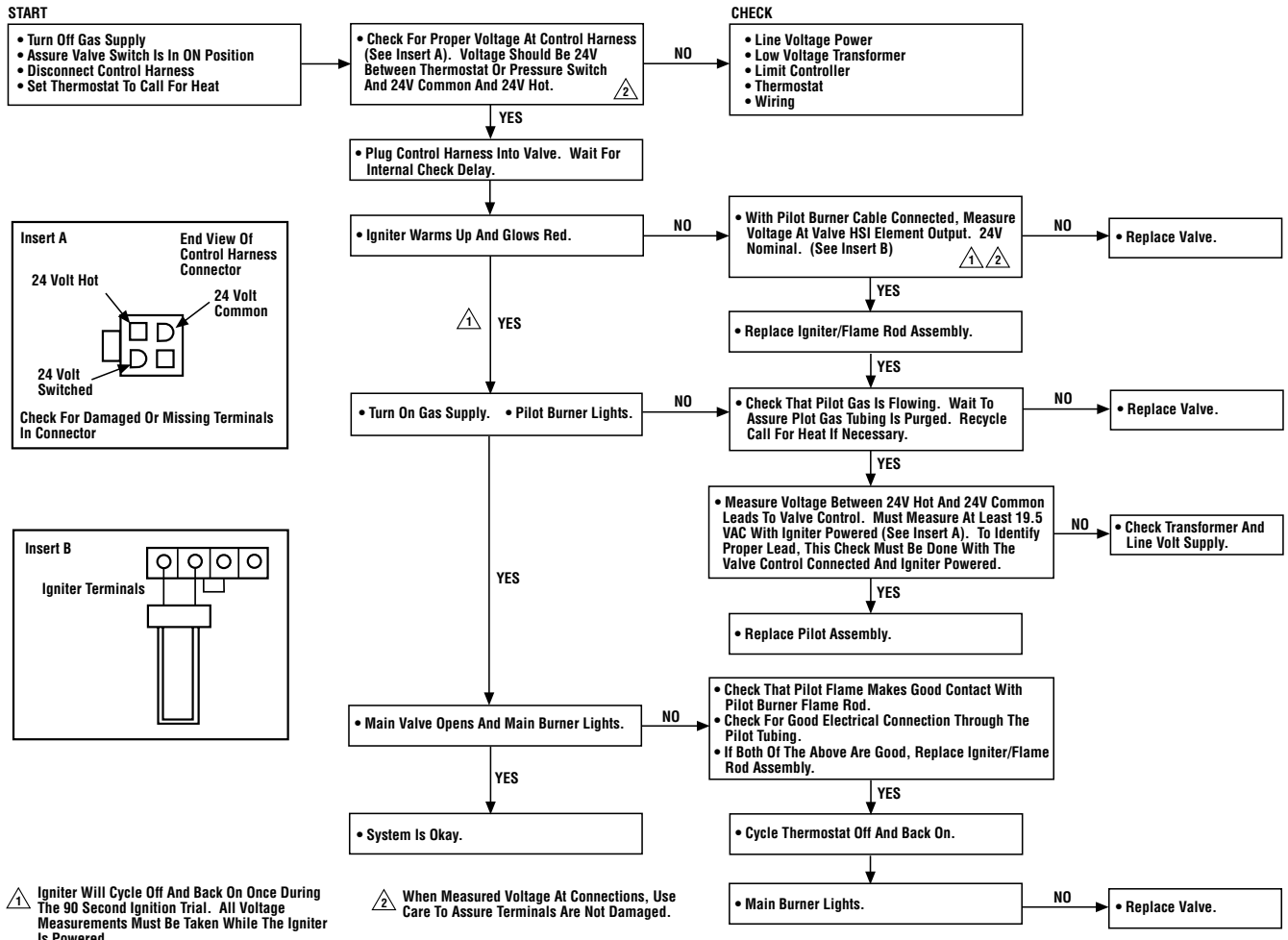

REPLACEMENT PARTS LIST

No.	DESCRIPTION	EDV3530		EDV4035		EDV4540	
		Part No.	Qty.	Part No.	Qty.	Part No.	Qty.
	Gas Fireplace Assembly	-	-	-	-	-	-
1.	Hood	H3895	1	H3896	1	H3897	1
2.	Louver Assembly, Top	H3726	1	H2727	1	H3728	1
3.	Louver Assembly, Bottom	H3734	1	H3735	1	H3736	1
4.	Enclosure, Glass Front (Complete)	91L18	1	H3724	1	91L16	1
5.	Bustle, Top	H4964	1	H3741	1	H3742	1
6.	Bustle, Bottom	91L25	1	H3729	1	H3730	1
7.	Nameplate (Brand)	12L15	1	12L15	1	12L15	1
8.	Latch	69L21	2	69L21	2	69L21	2
9.	Catch, Door, Magnetic	69L31	1	69L31	1	69L31	1
10.	Log Set (Complete)	55M02	1	55M03	1	55M03	1
11.	Burner Assembly	55M29	1	55M30	1	55M30	1
12.	Grate Assembly	H4990	1	H4991	1	H4991	1
13.	Venturi/Air shutter	H3707	1	H3707	1	H3707	1
14.	Orifice, Main Burner - Nat. Gas	69L96	1	18L40	1	99K77	1
14.	Orifice, Main Burner - LP Gas	39L10	1	37G00	1	H0922	1
15.	Ceramic Panel Floor (Complete)	55M46	1	55M47	1	55M48	1
16.	Bag of Rockwool	88L53	1	88L53	1	88L53	1
17.	ON/OFF Control Switch	80L41	1	80L41	1	80L41	1
18a.	Modesty Panel, Millivolt	H3382	1	H3382	1	H3384	1
18b.	Modesty Panel, Electronic	H3381	1	H3381	1	H3383	1
19.	Gasket - Venturi Tube Mounting	43K85	1	43K85	1	43K85	1
20.	Gas Line Flexible Connector	93L32	1	93L32	1	93L32	1
21.	Magnet	H3699	1	H3699	1	H3699	1

GAS CONTROLS — SIT MILLIVOLT

No.	DESCRIPTION	Natural		Propane	
		Part No.	Qty.	Part No.	Qty.
30.	Gas Valve - SIT	43K07	1	88J53	1
31.	Piezo Igniter	10K86	1	10K86	1
32.	Pilot Assembly	69L17	1	69L18	1
33.	Pilot Generator	60J79	1	60J79	1
34.	Thermocouple	74L57	1	74L57	1
35.	Pilot Tube	74L56	1	74L56	1
36.	Electrode And Cable	74L58	1	74L58	1

GAS CONTROLS — HONEYWELL ELECTRONIC

No.	DESCRIPTION	Natural	
		Part No.	Qty.
40.	Gas Valve - Honeywell	62L18	1
41.	Pilot Assembly	62L14	1
42.	Transformer	42J32	1
43.	Ignitor Assembly (Kit)	87L54	1

REPLACEMENT PARTS

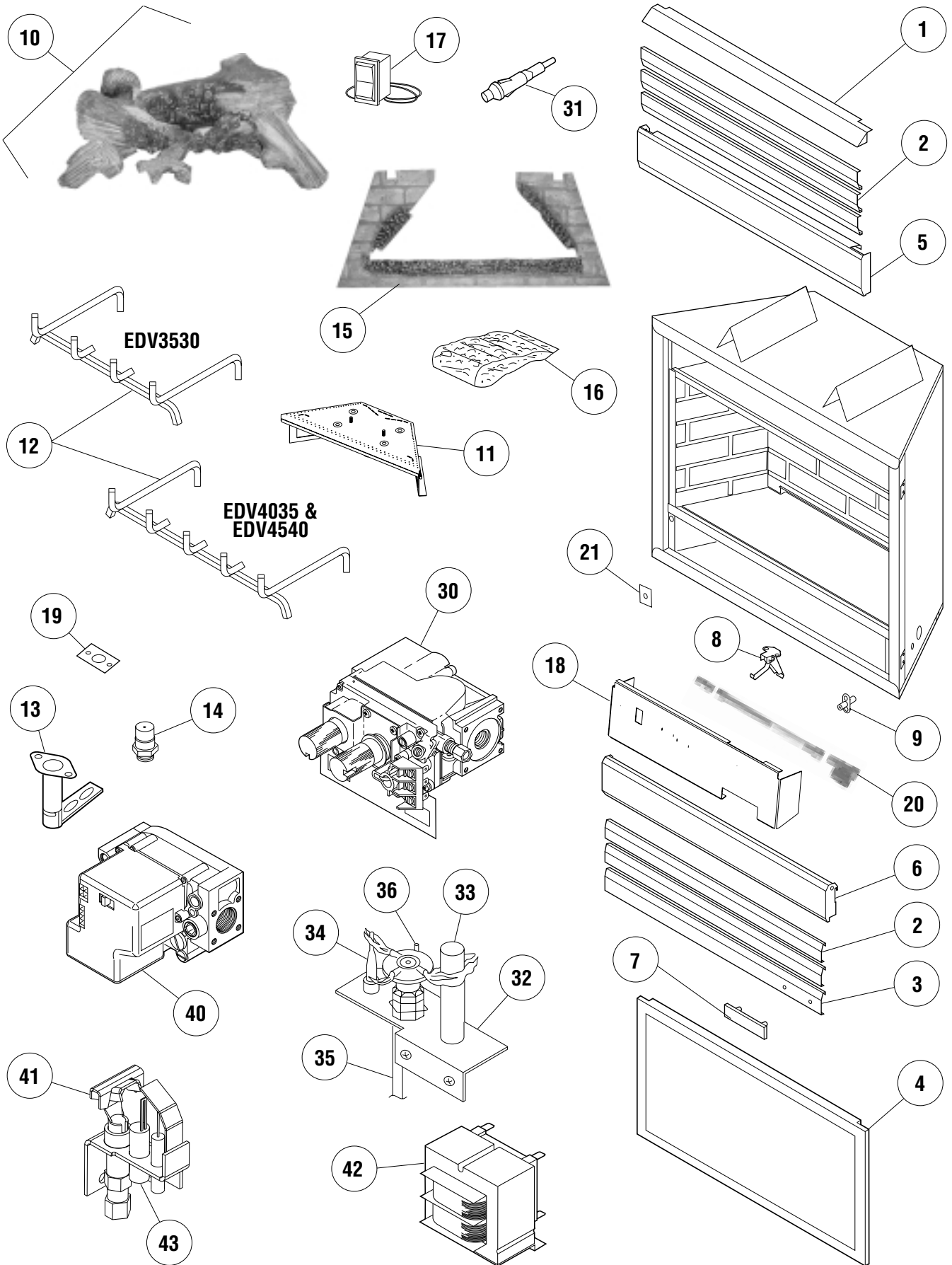

NOTE: DIAGRAMS & ILLUSTRATIONS NOT TO SCALE.

Lennox Hearth Products reserves the right to make changes at any time, without notice, in design, materials, specifications, prices and also to discontinue colors, styles and products. Consult your local distributor for fireplace code information.

Printed in U.S.A. © 2003 by Lennox Hearth Products

P/N 875,021M REV. G 03/2007

The logo features the word "LENNOX" in a bold, italicized, sans-serif font. The letters are contained within a stylized, horizontal oval shape that is open on the right side. A small "TM" trademark symbol is located at the bottom right of the oval.

HEARTH PRODUCTS

1110 West Taft Avenue • Orange, CA 92865